

# High Voltage Stackable Energy Storage Battery

Installation and Operation Manual

[www.aforeenergy.com](http://www.aforeenergy.com)



**Afore**

Afore New Energy Technology (Shanghai) Co., Ltd.

T +86-21-54326236 F +86-21-54326136 E [info@aforeenergy.com](mailto:info@aforeenergy.com)

Ad Building 7, No.333 Wanfang Rd, Minhang District, Shanghai, China. 201112

**Afore**

Afore New Energy Technology (Shanghai) Co., Ltd.



# AF2500W-HB Operation Manual

This Manual introduces AF2500W-HB

AF2500W-HB is a High-voltage Lithium-iron Phosphate Battery energy storage system. Please read this manual before you install the battery and follow the instruction carefully during the installation process.

## Catalogue

<b>1 Technical Specication</b> .....	1-2
<b>2 Safety Information</b>	
2.1 General Safety .....	3
2.2 Personal Safety .....	3
2.3 Electrical Safety .....	4-5
2.4 Transportation Safety .....	6
<b>3 System Information</b>	
3.1 Product Introduction .....	7
3.2 Specification .....	7-8
3.2.1 Battery Module .....	7
3.2.2 High-voltage box .....	7
3.3 Port Definitions .....	8-10
3.3.1 Connection Area .....	8
3.3.2 Start .....	8
3.3.3 Link Com Port .....	9
3.3.4 Link Power/Link in/Link out .....	9
3.3.5 LED Indicator Definition .....	10
<b>4 Installation</b>	
4.1 Tools .....	11
4.2 Checking Deliverables .....	12-14
4.3 Installation .....	15-25
4.4 Disassembly, Addition of New Modules, or Replacement of Units.....	26
<b>5 Commissioning Procedure</b> .....	27
<b>6 Maintenance</b> .....	28

## 2. Technical Specification

Power Module Model	Number of power modules	Number of battery Modules	Battery System Capacity	Battery Cell Technology	Battery System Voltage	Operating Voltage Range	Dimension (W*D*H)	Net Weight
AF2500 W-HB	1	3	7.68kWh	Li-iron(LFP)	153.6V	134.4~168.48V	600*210*870(mm) 23.62*8.27*34.25(inch)	103.5kg (228.18 lb)
		4	10.24kWh		204.8V	179.2~224.64V	600*210*1030(mm) 23.62*8.27*40.55(inch)	130kg (286.60 lb)
		5	12.8kWh		256V	224~280.8V	600*210*1190(mm) 23.62*8.27*46.85(inch)	156.5kg (345.02 lb)
		6	15.36kWh		307.2V	268.8~336.96V	600*210*1350(mm) 23.62*8.27*53.15 (inch)	183kg (403.45 lb)
		7	17.92kWh		358.4V	313.6~393.12V	600*210*1510(mm) 23.62*8.27*59.45 (inch)	209.5kg (461.87 lb)
		8	20.48kWh		409.6V	358.4~449.28V	600*210*1670(mm) 23.62*8.27*65.75(inch)	236kg (520.29 lb)
		9	23.04kWh	460.8V	403.2~505.44V	600*210*1830(mm) 23.62*8.27*72.05(inch)	262.5kg (578.71 lb)	
		10	25.6kWh	512V	448~561.6V	600*210*1990(mm) 23.62*8.27*78.35 (inch)	289kg (637.14 lb)	

Scalability	Installation	Depth of Discharge	Battery System Charge Current (recommend)	Battery System Charge Current (Max)	Battery System Discharge Current (recommend)	Battery System Discharge Current (Max)	Display	Certificates
Max. Up to 10 systems in series operation	Floor stand	90%	25A	50A	25A	50A	The information of the Battery, such as SOC, battery status	IEC62619 / IEC61000 / UN38.8 / MSDS
Communication Port	Protection Class	Charging temperature	Discharge temperature	Humidity	Max. operating altitude	Warranty	Cooling	
RS485, CAN	IP65	0°C~55°C (32°F-131°F)	-20°C~60°C (-4°F-140°F)	5%-95%	2,000mm (6,562ft.)	10 years	Natural convection	

Each Single Battery Module Specification	Battery Cell Capacity	Configuration	Power module dimensions (W*D*H)	Battery Module dimensions (W*D*H)	Lampstand Module dimensions (W*D*H)	Battery Module Dimensions (W*D*H)
	50Ah	1P16S	600*210*250 (mm) / 23.62*8.27*9.84 (inch)	600*210*160 (mm) / 23.62*8.27*6.30 (inch)	600*210*90 (mm) / 23.62*8.27*3.54 (inch)	600*210*50 (mm) / 23.62*8.27*1.96 (inch)
	Battery Module Capacity	Battery Module Voltage	Power Module Weight	Battery Module Weight	Lampstand Module Weight	Top cap Module Weight
	2.56kWh	51.2V	14kg (30.86lb)	27kg (59.52)	5kg (11.02lb)	2.5kg (5.51lb)



## 2. Safety Information

### 2.1 General Safety

Please read the user manual carefully and check all the safety instructions on the equipment and in this document.

The "DANGER", "WARNING", and "NOTICE" statements in this document do not cover all the safety instructions. They are only supplements to the safety instructions.

For user safety and utilization efficiency of this manual, a list of symbols is designed to alert people from danger. You must understand and comply with the emphasized information to avoid personal injury and property damage. Relative safety symbols have been listed below.

 <b>Danger</b>	DANGER indicates a hazardous situation which, if not avoided, will result in serious injury and/or fire.
 <b>Warning</b>	WARNING indicates a hazardous situation which, if not avoided, will result in property loss and/or void the warranty.
 <b>NOTICE</b>	NOTICE indicates normal situation which, if not avoided, will result in damage to the battery.

#### NOTICE

Follow local laws and regulations when installing, operating, or maintaining the equipment. The safety instructions in this document are only supplements to local laws and regulations.

### 2.2 Personal Safety

#### Personal Requirements

People who plan to install or maintain battery equipment must be trained, understand all necessary safety precautions, and are able to correctly perform all operations. Only qualified professionals or trained people are allowed to install, operate, and maintain the equipment.







#### **⚠ DANGER**

- Keep the batteries away from children and pets.
- Do not touch the energized battery, the temperature of the battery enclosure may increase during operation.
- Do not touch the energized battery terminals.
- Do not stand on, lean on, or sit on the battery.

### 2.3 Electrical Safety

#### Symbols on Battery

There are some electrical symbols on battery relate to electrical safety. Please make sure you have fully understood them before installation.

	Electrical danger	Voltage exists when the battery is powered on. Only qualified engineers are allowed to operate.
	Earth connector	Earth connection.
	DC positive and negative connectors	Identify positive and negative connectors of DC power source.
	CE mark	The product meets CE certification.
	WEEE label	Batteries must not be disposed with general waste. It must be appropriately recycled in accordance with local regulations.
	Recycle	Batteries can be recycled, please refer to your local regulations regarding the correct disposal methods.

---

## Electrical Safety

### DANGER

- Before installation, ensure that the equipment is complete and intact. Otherwise, electric shock or fire may occur.
- Do not connect or disconnect power cables when battery is power-on. Which may cause electric arcs and sparks, moreover fire or personal injury.
- Before connecting a power cable, check the positive or negative connectors are correct.
- Do not connect the battery with different batteries in parallel.
- Do not connect the battery with AC supply directly.
- Do not connect the battery with PV wiring directly.
- Do not connect the batteries in series.
- Do not connect the battery to faulty or unqualified inverter or charger.
- Do not create short circuits with the external connection.
- Make sure the grid is cut off and the battery is powered off before maintenance.
- Make sure the earth cable is connected correctly before operation.

### WARNING

- Recharge the battery in every six months if not in use.
- Recharge the battery within 10 days after the battery is fully discharged(SOC=0%).
- Ensure the battery cable is installed correctly.
- When the battery is being installed or repaired, ensure the battery is powered off and and isolated. Using a multimeter check to ensure there is no voltage in the positive and negative terminals.

### CAUTION

- Please use appropriately insulated tools for installation and maintenance.
- Please check the LED status indicator when the battery is powered on.
  
- Please ensure the communication cable is connected correctly between the battery and the inverter.
- Please check for inverter alarms and the SOC reading once communication is established between the inverter and the battery.

## Environment Safety

### WARNING

- Ensure the battery is installed in a dry and well-ventilated location.
- The installation position must be away from direct sunlight and rain.
- The installation position must be far away from potential sources of fire..
- The installation position must be far away from all sources of water.
- Do not install the equipment in locations that contain flammable gases and/or flammable liquids.
- The operation and service life of the battery depends on the operating temperature. Operate the battery at a temperature equal to or better than the ambient temperature. The recommended operating temperature range is from 0°C to 30°C.

## 2.4 Transportation Safety

### WARNING

- The products have passed UN38.3 certification.
- The products have MSDS documents available.
- The products belong to class 9 dangerous goods.
- **Please protect the packing case from the following situations:**
  - Being dampened by rains, snows, or falling into water.
  - Falling down or mechanical impact.
  - Being upside-down or tilted.

## 3. System Information

### 3.1 Product Introduction

AF2500W-HB is a high-voltage battery storage system based on lithium-iron phosphate technology. It is used to primarily store excess PV power that is generated by an inverter based on PV system.

### 3.2 Specification

#### 3.2.1 Battery Module

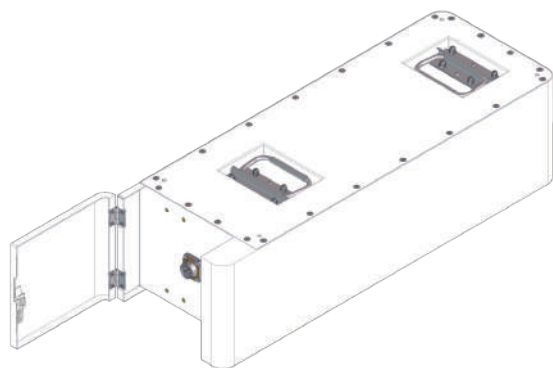

#### 3.2.2 High-voltage box

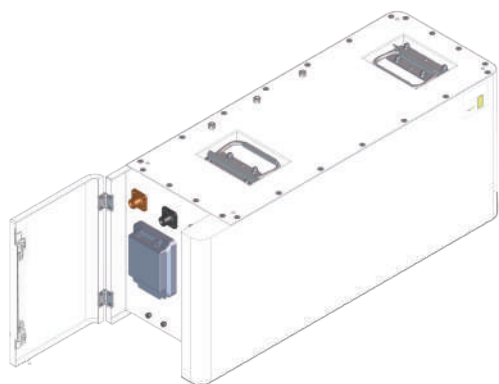

### 3.3 Port definitions

#### 3.3.1 Connection Area

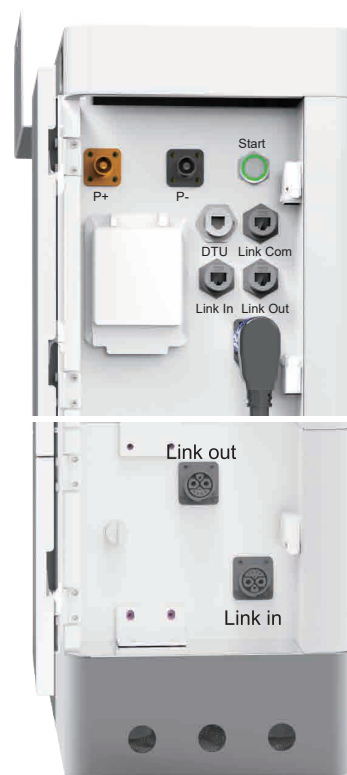

#### 3.3.2 Start

##### Switch On

First, open the air switch and long press the start button of the HV box (connected to the inverter) for more than 5s. The "normal" LED indicator on the front panel will flash. L1 to L5 display battery SOC, and L6 displays battery status. The HV box equipped with the battery management system will automatically code and assign an ID to each battery module, and the battery will work normally. (First switch on the air switch, then press the weak current button. After discharging and precharging the battery pack, the battery can work normally to prevent surge current from damaging the inverter.)

## (2) OFF

Press Start button of the High-voltage box (which is connected to the inverter) for more than 5s, the LED indicator on the front panel will flash, and then release the button, the master pack will shut down after all the slave packs shut down (Sleep Mode).

Tip: If the system does not work, keep the internal DC switch on the battery cluster closed.

### 3.3.3 Link Communication Port

The Link Communication Port is the interface between the battery packs and the inverter. The inverter retrieves the battery data such as SOC, DOD, charge current via this connection.

RJ45 port supports CAN / RS485 / RS232 communication protocol.

CAN/RS485 communication terminal (RJ45 port) connects to the inverter and follows CAN / RS485 protocol.

RS232 communication terminal (RJ45 port) follows RS232 protocol, for manufacturer or professional engineer to debug or service.

PIN	Definition
Pin 1	RS485-B (to PCS, reserved)
Pin 2	RS485-A (to PCS, reserved)
Pin 3	GND_2
Pin 4	CANH (to PCS)
Pin 5	CANL (to PCS)
Pin 6	RS232_TX
Pin 7	RS232_RX
Pin 8	RS232_GND

### 3.3.4 Link Power/Link in/Link out

Link Power/Link in/Link out are used for the communication between the battery packs. The battery pack close to the inverter is the master pack, others are the slave pack.

### 3.3.5 LED Indicator Definition

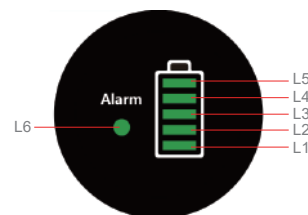

flash 1 - every 0.25s on/3.75s off

flash 2 - every 0.5s on/ 0.5s off









flash 3 - every 0.5s on / 1.5s off

#### LED Indicators Definitions

Status	Normal/Alarm/Protection	ALM	Battery Level IndicatorLED					Description
		●	●	●	●	●		
Shut down		OFF	OFF	OFF	OFF	OFF	OFF	ALL OFF
Standby	Normal	OFF	According to the battery level					Indicates Standby Module low voltage
	Alarm	Flash 3						
Charging	Normal	OFF	According to the battery level(The highest battery indicator LED Flash 2)					The highest battery level LED flashes (flash 2), and the ALM does not flash when the overcharge alarm occurs  If there is no grid power, the indicator light turns to standby Stop charging
	Alarm	Flash 3						
	Overcharge protection	OFF	Light	Light	Light	Light	Light	
	Protection	Light	OFF	OFF	OFF	OFF	OFF	
Discharge	Normal	OFF	According to the battery level					Stop discharging  Stop discharging
	Alarm	Flash 3						
	Under voltage protection	OFF	OFF	OFF	OFF	OFF	OFF	
	Protection	Light	OFF	OFF	OFF	OFF	OFF	
Fault		Light	OFF	OFF	OFF	OFF	OFF	Stop charging and discharging







## 4. Installation

### 4.1 Tools

Tools			
Installation	Rubber mallet 	Star screwdriver 	Hammer drill (10 mm) 
	ESD gloves 	Safety goggles 	Anti-dust respirator 
	Safety shoes 	Level 	

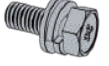



### 4.2 Checking deliverables

After unpacking the battery, check whether deliverables are intact and complete.

Packing list of Battery Box				
No.	Part name/size	Quantity	Picture	Used for
1	Battery box	1		
2	Fixing plate	1		Fixing plate for multiple batteries
3	Phillips hexagon screw with three combination	4		To fix the fixing plate
4	Flat locating	4		To position multiple packs
5	V1.0_M23 Self-locking 8-core 2_1_5_Double-pin 90°with cord_length 80±5mm	1		Connection cable between multiple batteries
6	moisture-proof desiccant	2		Moisture proof



Packing list of HV Box				
No.	Part name/size	Quantity	Photo	Used for
1	High-voltage box	1		
2	Foot	4		To let the base stand on
3	Base	1		To put at the bottom of the battery
4	Top	1		Install at the top of the battery
5	L-shape wall hanging bracket	1		Wall hanging bracket
6	stainless steel plate	1		
7	Black waterproof clamping ring plug rod	4		Waterproof plug rod for top cover
8	Black Iron Positioningpin	4		Used for positioning multiple packs
9	self-locking plug nut	1		Plug to conduct the circuit
10	High voltage box connection cable	1		

11	304 stainless steel Wall plug	3		To fix the wall hanging bracket
12	Phillips hexagon screw with three combination	4		To lock the wall hanging bracket and grounding of the base
13	Phillips slotted pan head screws	4		To lock the top
14	Phillips hexagon screw with three combination	4		To fix multiple packs
15	Positive power cable	1		Battery positive power cable
16	Negative power cable	1		Battery negative power cable
17	yellow-green two-color grounding cable	1		Grounding cable
18	Super five categories RJ45 shielded crystal head	4		RJ45 Crystal head
19	Communication cable	2		Communication cable
20	moisture-proof desiccant	2		Moisture proof

### 4.3 Installation

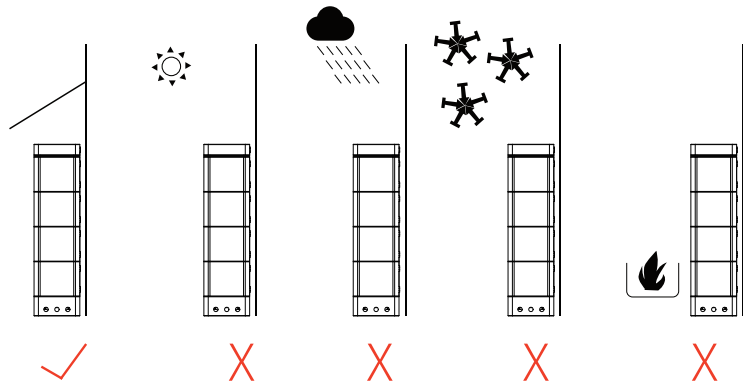

#### Step 1

Place the base against the wall, the distance between the base and the wall is 30mm as followed.

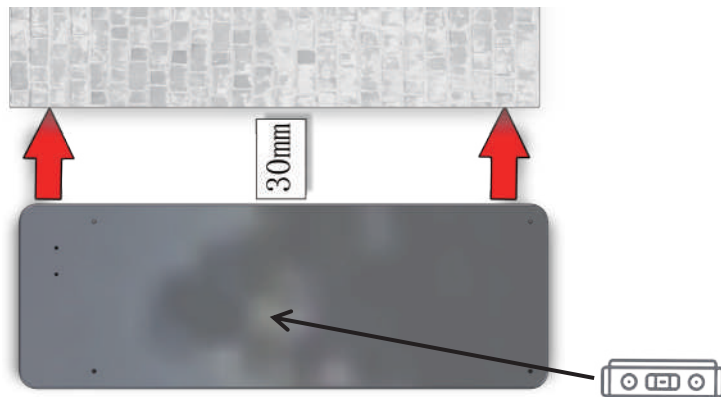

Note: Levelness of the base is less than 2mm.

#### Step 2

Screw the locating pin into the base and put the first battery pack on the base.

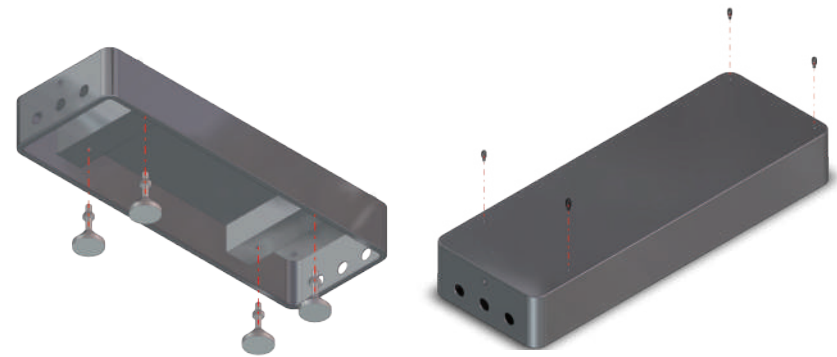

(2.1)

(2.2)

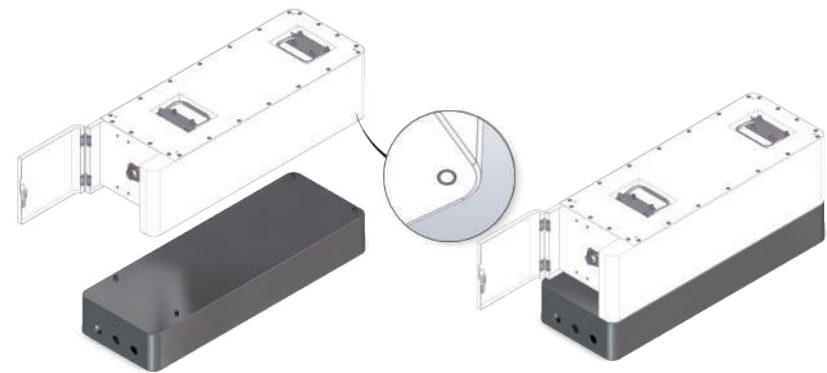

(2.3)

(2.4)

### Step 3

Secure the battery module to the base with the stainless steel plate.

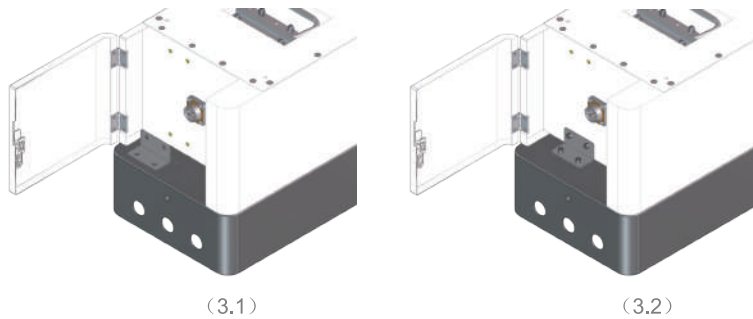

### Step 4

Place the next battery module on top of the first battery module and secure the battery modules with the fixing plate. Repeat this step until all battery modules have been installed. Place the high-voltage box on top of the last module and secure it using the L-shape wall hanging bracket.

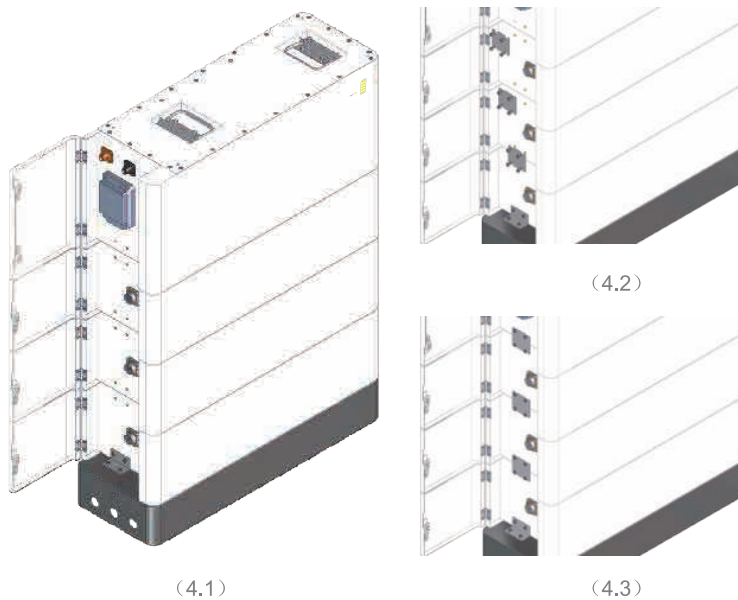

### Step 5

Attached the L-shape wall hanging bracket onto the high voltage box as shown in the image.

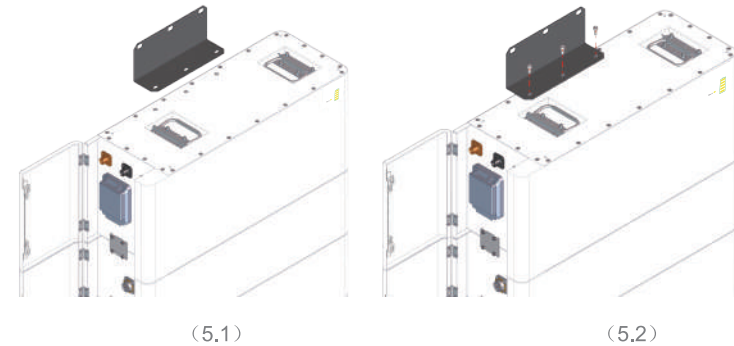

### Step 6

Drill three holes in the wall and insert three screw plugs. Insert three screws to secure the L-shape wall hanging bracket to the wall.

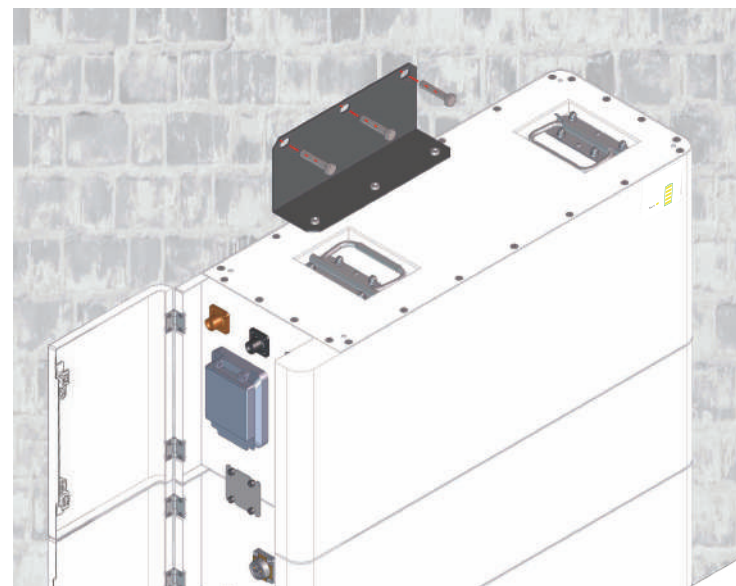

### Step 7

Secure the top of the high voltage box with the provided screws.

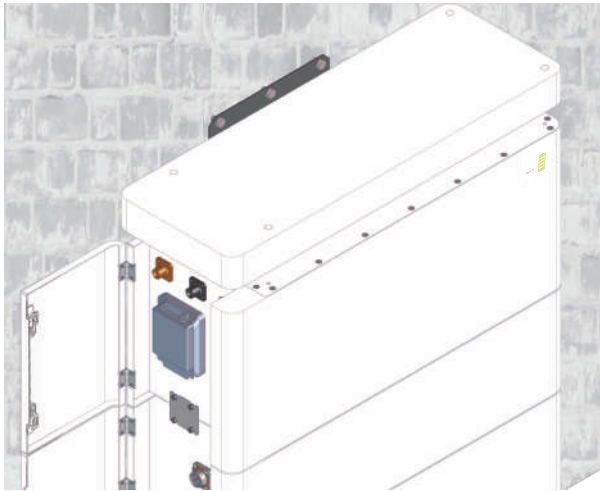

(7.1)

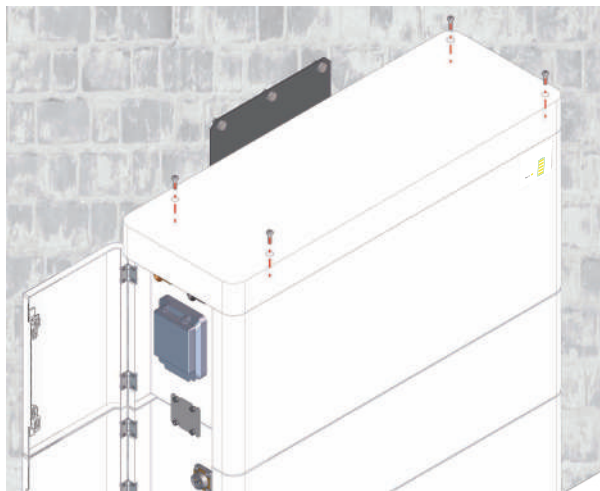

(7.2)

### Step 8

Connect the small fixing plate between each modules as follows.



### Step 9

Connect the power cables between the battery modules and the high-voltage box as shown. According to the number of battery layers used by the customer, the link harnesses are connected from top to bottom. Finally, self-locking plug nut to complete the circuit. The wiring harness must be connected in the sequence shown in Figure 9.1-9.2-9.3. Otherwise, risks may arise.



(9.1)

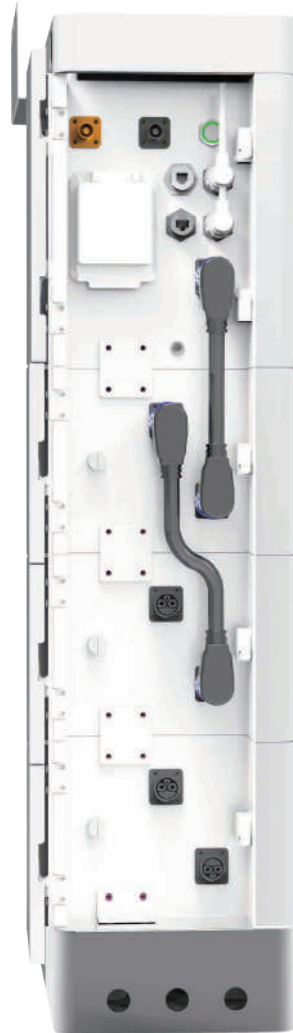

(9.2)

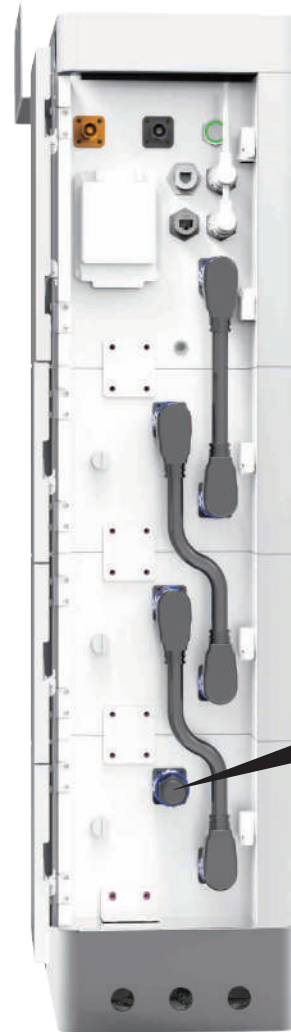

(9.3)



Self locking nut

 **DANGER**

Make sure you hear the connection terminal harness and self-locking plug nut click into the slot to secure the connection. The clicking sound applies to both the battery interconnect cables AND the self locking nut"



### Single cluster connection method:

Connect the power through P+ and P-  
Connect the first High-voltage box Link Com Terminal to the inverter BMS port for communication between inverter and battery.

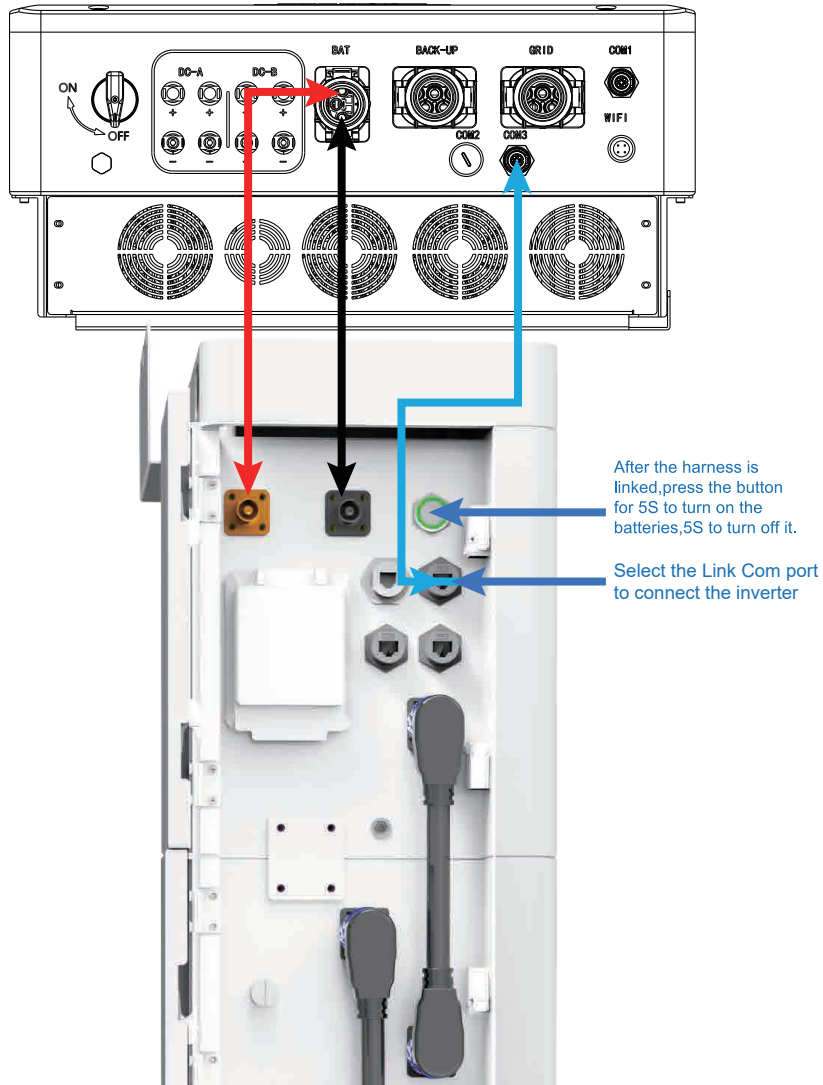

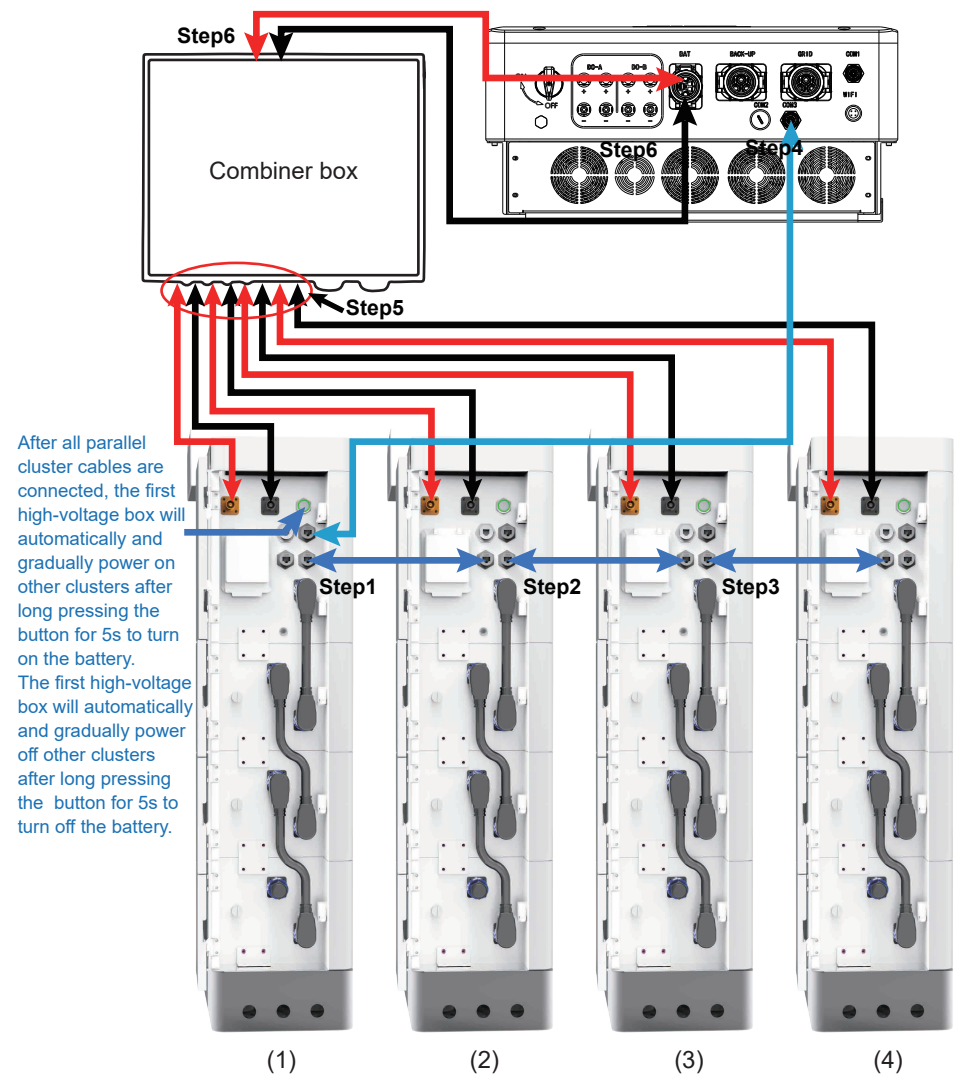

### Multi-clusters connection method:

1. Connect the first High-voltage box Link Com Terminal to the inverter BMS port for communication between inverter and battery.
2. Then the P+ and P- ports of the connected single cluster are combined for output through the combiner box.





 <b>Danger</b>	<p>Ensure power cables are installed with the correct polarity. A dangerous situation may arise if the polarities are reversed.</p>
 <b>Danger</b>	<p>Do not create a short circuit between the positive and negative terminals of the battery. Ensure the polarity is correct during installation.</p>
 <b>Warning</b>	<p>Incorrect communication cable connection will cause the battery system to operate in unexpected ways which may lead to system failure.</p>

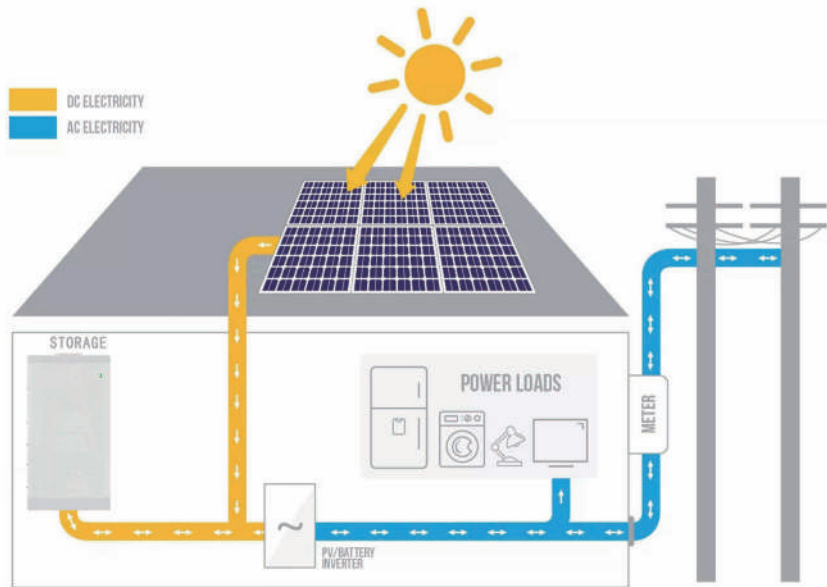

#### 4.4 Disassembly, Addition of New Modules, or Replacement of Units

**⚠ DANGER**

Regardless of whether a battery module is being added or whether the battery system is being temporarily or permanently disassembled, certain sections of the battery system will be required to be disconnected and taken apart. Proceed as follows:

- Shut down the battery in accordance with the "OFF" procedure in section 3.3.2
- Before disassembling, remove the "self locking nut" located on the last battery module
- To disassemble a section or the complete battery system and to avoid risk of potential electric shock, strictly follow the sequence of disassembly in sections 4.4.1, 4.4.2, 4.4.3
- To re-assemble the battery system, refer to section 3.4 Installation and ensure the self locking nut is installed ONLY after the battery interconnections between each battery module and to the inverter have been completed.

**⚠ WARNING**

Regardless of whether a battery module is being added or whether the battery system is being temporarily or permanently disassembled, certain sections of the battery system will be required to be disconnected and taken apart. Proceed as follows:

- Shut down the battery in accordance with the "OFF" procedure in section 3.3.2
- Before disassembling, remove the "self locking nut" located on the last battery module
- To disassemble a section or the complete battery system and to avoid risk of potential electric shock, strictly follow the sequence of disassembly in sections 4.4.1, 4.4.2, 4.4.3
- To re-assemble the battery system, refer to section 3.4 Installation and ensure the self locking nut is installed ONLY after the battery interconnections between each battery module and to the inverter have been completed.

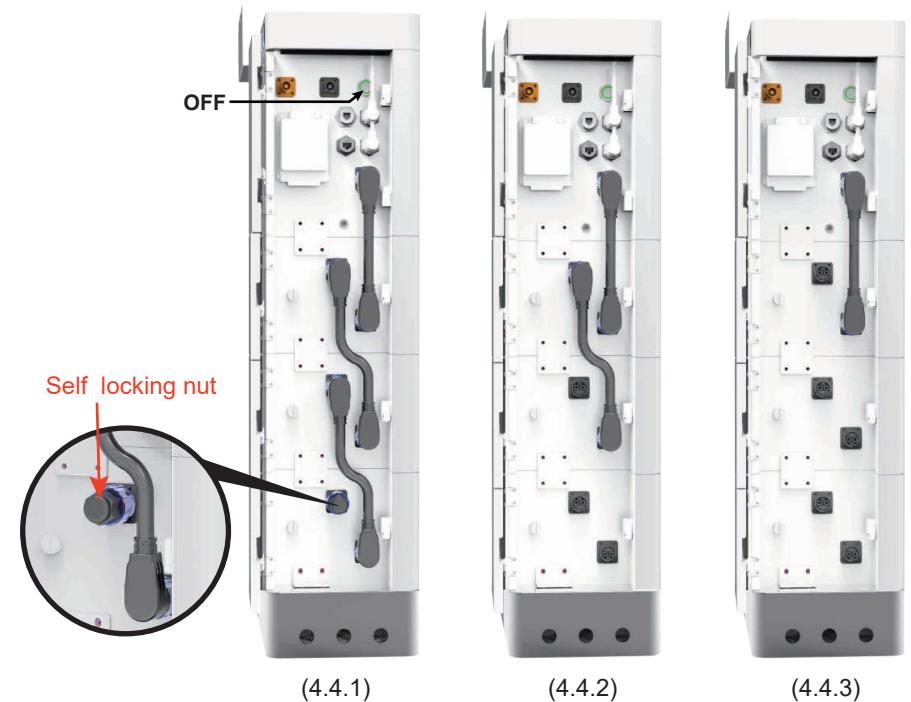

## 5. Commissioning Procedure

After all the cable (power and communication) connections are completed, please ensure the following:

- Ensure the DC switch on the inverter is OFF
- Ensure the AC switch that is connected to the grid and EPS output (if used) of the inverter is OFF
- Ensure the DC switch on the HV box is OFF

For commissioning we recommend the following steps:

- Turn the DC switch on the HV box ON
- Refer to section 2.3.2 Start for turning on the battery
- Wait until the HV box LED's on
- Wait until the inverter LED's on
- Turn on the DC switch on the inverter
- Set up the battery and the inverter on the App
- Turn on the AC switch that is connected to the grid and EPS output of the inverter

## 6. Maintenance

### ● Recharge Requirements During Normal Storage

Battery should be stored in an environment with temperature range between  $-10^{\circ}\text{C} \sim +45^{\circ}\text{C}$  and maintained regularly according to following table with 0.5C(25A) current till 100% SOC after long storage time.

Storage Environment Temperature	Relative Humidity of Storage Environment	Storage Time	SOC
Below $-10^{\circ}\text{C}$	/	Prohibit	/
$-10\sim 25^{\circ}\text{C}$	5%~70%	$\leq 12$ months	$30\% \geq \text{SOC} \geq 60\%$
$25\sim 35^{\circ}\text{C}$	5%~70%	$\leq 6$ months	$30\% \geq \text{SOC} \geq 60\%$
$35\sim 45^{\circ}\text{C}$	5%~70%	$\leq 3$ months	$30\% \geq \text{SOC} \geq 60\%$
Above $45^{\circ}\text{C}$	/	Prohibit	/

### ● Recharge Requirements When Over Discharged

Over discharged (90%DOD) battery should be recharged according to following table, otherwise over discharged battery will be damaged.

Storage Environment Temperature	Storage Time	Note
$-10\sim 25^{\circ}\text{C}$	$\leq 15$ days	Battery Pack disconnected to inverter
$25\sim 35^{\circ}\text{C}$	$\leq 7$ days	
$35\sim 45^{\circ}\text{C}$	$< 12$ hours	Battery Pack connected to inverter